

## Advantages

- Generation of power is continuous.
- Initial cost low compared to hydel plant.
- Less space required.
- This can be located near the load centre so that the transmission losses are reduced.
- It can respond to rapidly changing loads.

## Disadvantages

- Long time required for installation.
- Transportation and handling of fuels major difficulty.
- Efficiency of plant is less.
- Power generation cost is high compared to hydel power plant.
- Maintenance cost is high.

## HYDEL POWER PLANTS

Hydroelectric power plants convert the hydraulic potential energy from water into electrical energy. Such plants are suitable where water with suitable *head* are available. The layout covered in this article is just a simple one and only cover the important parts of hydroelectric plant.

### LAYOUT OF HYDEL POWER PLANT:

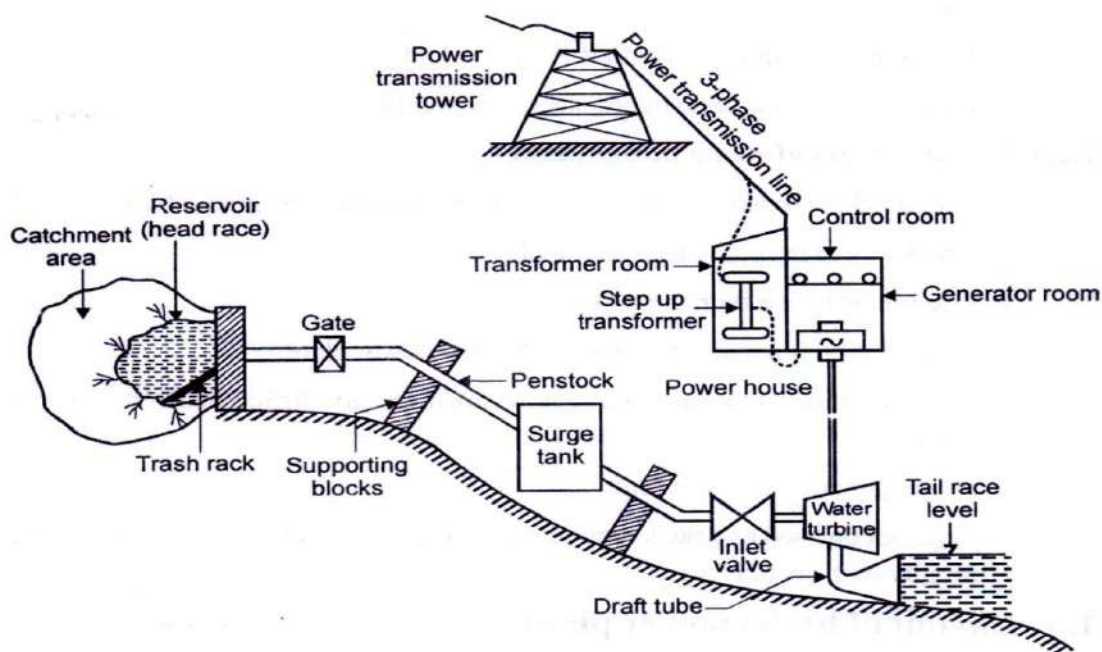

### **(1) Dam**

Dams are structures built over rivers to stop the water flow and form a reservoir. The reservoir stores the water flowing down the river. This water is diverted to turbines in power stations. The dams collect water during the rainy season and stores it, thus allowing for a steady flow through the turbines throughout the year. Dams are also used for controlling floods and irrigation. The dams should be water-tight and should be able to withstand the pressure exerted by the water on it. There are different types of dams such as arch dams, gravity dams and buttress dams. The height of water in the dam is called *head race*.

### **(2) Spillway**

A spillway as the name suggests could be called as a way for spilling of water from dams. It is used to provide for the release of flood water from a dam. It is used to prevent overtopping of the dams which could result in damage or failure of dams. Spillways could be controlled type or uncontrolled type. The uncontrolled types start releasing water upon water rising above a particular level. But in case of the controlled type, regulation of flow is possible.

### **(3) Penstock and Tunnels**

Penstocks are pipes which carry water from the reservoir to the turbines inside power station. They are usually made of steel and are equipped with gate systems. Water under high pressure flows through the penstock. A tunnel serves the same purpose as a penstock. It is used when an obstruction is present between the dam and power station such as a mountain.

### **(4) Surge Tank**

Surge tanks are tanks connected to the water conductor system. It serves the purpose of reducing water hammering in pipes which can cause damage to pipes. The sudden surges of water in penstock is taken by the surge tank, and when the water requirements increase, it supplies the collected water thereby regulating water flow and pressure inside the penstock.

### **(5) Power Station**

Power station contains a turbine coupled to a generator. The water brought to the power station rotates the vanes of the turbine producing torque and rotation of turbine shaft. This rotational torque is transferred to the generator and is converted into electricity.

The used water is released through the *tail race*. The difference between head race and tail race is called gross head and by subtracting the frictional losses we get the net head available to the turbine for generation of electricity.

### **Advantages**

- Water the working fluid is natural and available plenty.
- Life of the plant is very long.
- Running cost and maintenance are very low.
- Highly reliable.
- Running cost is low.
- Maintenance and operation costs are very less.
- No fuel transport problem.
- No ash disposal problem.

### **Disadvantages**

- Initial cost of plant is very high.
- Power generation depends on quantity of water available which depends on rainfall.
- Transmission losses are very high.
- More time is required for erection.

## **DIESEL POWER PLANTS**

Diesel power plants produce power from a diesel engine. Diesel electric plants in the range of 2 to 50 MW capacities are used as central stations for small electric supply networks and used as a standby to hydroelectric or thermal plants where continuous power supply is needed. Diesel power plant is not economical compared to other power plants.

The diesel power plants are cheaply used in the fields mentioned below.

1. Mobile electric plants
2. Standby units
3. Emergency power plants
4. Starting stations of existing plants
5. Central power station etc.

## LAYOUT OF DIESEL POWER PLANT:

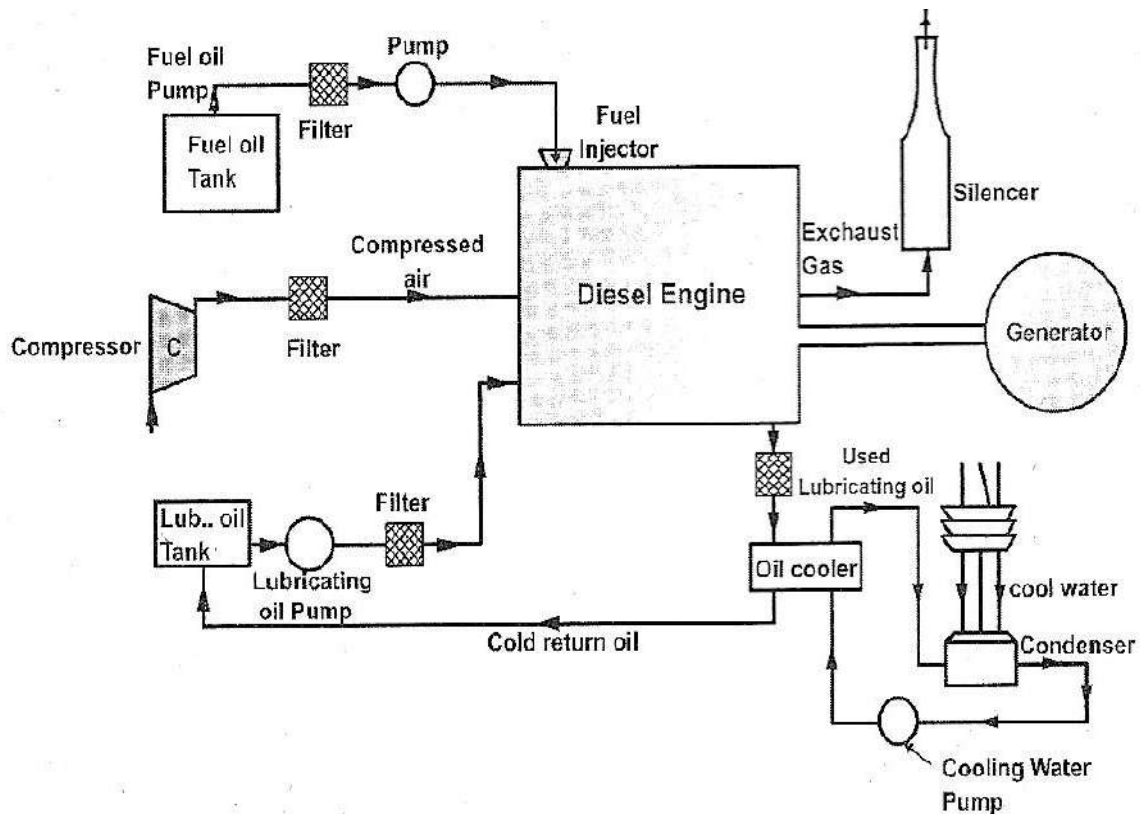

Figure shows the arrangements of the engine and its auxiliaries in a diesel power plant.

The major components of the diesel power plant are:

### 1) Engine

Engine is the heart of a diesel power plant. Engine is directly connected through a gear box to the generator. Generally two-stroke engines are used for power generation. Now a days, advanced super & turbo charged high speed engines are available for power production.

### 2) Air supply system

Air inlet is arranged outside the engine room. Air from the atmosphere is filtered by air filter and conveyed to the inlet manifold of engine. In large plants supercharger/turbocharger is used for increasing the pressure of input air which increases the power output.

### 3) Exhaust System

This includes the silencers and connecting ducts. The heat content of the exhaust gas is utilized in a turbine in a turbocharger to compress the air input to the engine.

### 4) Fuel System

Fuel is stored in a tank from where it flows to the fuel pump through a filter. Fuel is injected to the engine as per the load requirement.

### **5) Cooling system**

This system includes water circulating pumps, cooling towers, water filter etc. Cooling water is circulated through the engine block to keep the temperature of the engine in the safe range.

### **6) Lubricating system**

Lubrication system includes the air pumps, oil tanks, filters, coolers and pipe lines. Lubricant is given to reduce friction of moving parts and reduce the wear and tear of the engine parts.

### **7) Starting System**

There are three commonly used starting systems, they are;

- 1) A petrol driven auxiliary engine
- 2) Use of electric motors.
- 3) Use of compressed air from an air compressor at a pressure of 20 Kg/cm.

### **8) Governing system**

The function of a governing system is to maintain the speed of the engine constant irrespective of load on the plant. This is done by varying fuel supply to the engine according to load.

### **Advantages**

- Diesel power plants can be quickly installed and commissioned.
- Quick starting.
- Requires minimum labour.
- Plant is smaller, operate at high efficiency and simple compared to steam power plant.
- It can be located near to load centres.

### **Disadvantages**

- Capacity of plant is low.
- Fuel, repair and maintenance cost are high.
- Life of plant is low compared to steam power plant.
- Lubrication costs are very high.
- Not guaranteed for operation under continuous overloads.
- Noise is a serious problem in diesel power plant.
- Diesel power plant cannot be constructed for large scale.

## NUCLEAR POWER PLANTS

**Nuclear power** is the use of sustained or controlled **nuclear fission** to generate heat and do useful work. Nuclear Electric Plants, Nuclear Ships and Submarines use controlled nuclear energy to heat water and produce steam, while in space, nuclear energy decays naturally in a radioisotope thermoelectric generator. Scientists are experimenting with fusion energy for future generation, but these experiments do not currently generate useful energy.

Nuclear power provides about 6% of the world's energy and 13–14% of the world's electricity, with the U.S., France, and Japan together accounting for about 50% of nuclear generated electricity.

Also, more than 150 naval vessels using nuclear propulsion have been built. Just as many conventional thermal power stations generate electricity by harnessing the thermal energy released from burning fossil fuels, nuclear power plants convert the energy released from the nucleus of an atom, typically via nuclear fission.

### LAYOUT OF NUCLEAR POWER PLANT:

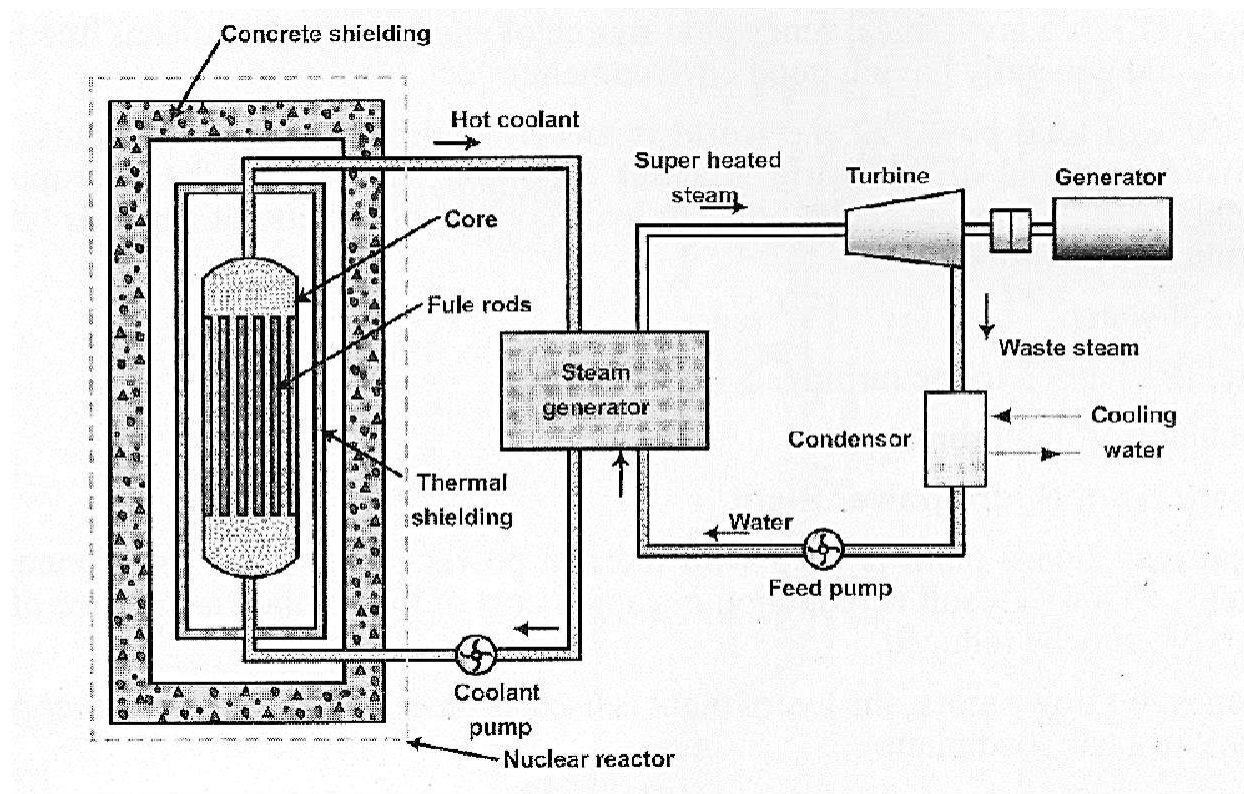

## NUCLEAR REACTOR

A nuclear reactor is an apparatus in which heat is produced due to nuclear fission chain reaction. Fig. shows the various parts of reactor, which are as follows:

1. Nuclear Fuel
2. Moderator
3. Control Rods
4. Reflector
5. Reactors Vessel
6. Biological Shielding
7. Coolant.

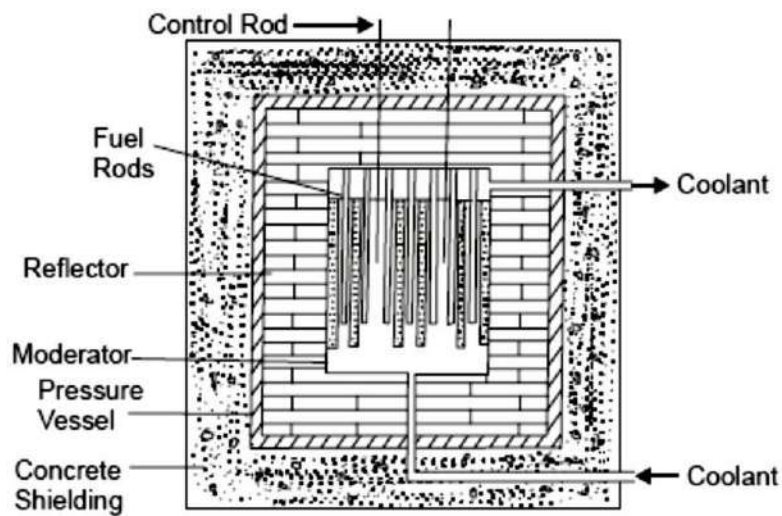

Nuclear reactor

### 1. Nuclear Fuel

Fuel of a nuclear reactor should be fissionable material which can be defined as an element or isotope whose nuclei can be caused to undergo nuclear fission by nuclear bombardment and to produce a fission chain reaction. It can be one or all of the following  $U^{233}$ ,  $U^{235}$  and  $Pu^{239}$ .

Natural uranium found in earth crust contains three isotopes namely  $U^{234}$ ,  $U^{235}$  and  $U^{238}$  and their average percentage is as follows:

$U^{238}$  - 99.3%

$U^{235}$  - 0.7%

$U^{234}$  - Trace

## **2. Moderator**

In the chain reaction the neutrons produced are fast moving neutrons. These fast moving neutrons are far less effective in causing the fission of U235 and try to escape from the reactor. To improve the utilization of these neutrons their speed is reduced. It is done by colliding them with the nuclei of other material which is lighter, does not capture the neutrons but scatters them. Each such collision causes loss of energy, and the speed of the fast moving neutrons is reduced. Such material is called Moderator.

The slow neutrons (Thermal Neutrons) so produced are easily captured by the nuclear fuel and the chain reaction proceeds smoothly. Graphite, heavy water and beryllium are generally used as moderator

## **3. Control Rods**

The Control and operation of a nuclear reactor is quite different from a fossil fuelled (coal or oil fired) furnace. The energy produced in the reactor due to fission of nuclear fuel during chain reaction is so much that if it is not controlled properly the entire core and surrounding structure may melt and radioactive fission products may come out of the reactor thus making it uninhabitable. This implies that we should have some means to control the power of reactor. This is done by means of control rods.

Control rods in the cylindrical or sheet form are made of boron or cadmium. These rods can be moved in and out of the holes in the reactor core assembly. Their insertion absorbs more neutrons and damps down the reaction and their withdrawal absorbs less neutrons. Thus power of reaction is controlled by shifting control rods which may be done manually or automatically.

## **4. Reflector**

The neutrons produced during the fission process will be partly absorbed by the fuel rods, moderator, coolant or structural material etc. Neutrons left unabsorbed will try to leave the reactor core never to return to it and will be lost. Such losses should be minimized. It is done by surrounding the reactor core by a material called reflector which will send the neutrons back into the core. The returned neutrons can then cause more fission and improve the neutrons economy of the reactor.

Generally the reflector is made up of graphite and beryllium.

## **5. Reactor Vessel**

It is a strong walled container housing the core of the power reactor. It contains moderator, reflector, thermal shielding and control rods.



## **6. Biological Shielding**

Shielding the radioactive zones in the reactor from possible radiation hazard is essential to protect the operating men from the harmful effects. During fission of nuclear fuel, alpha particles, beta particles, deadly gamma rays and neutrons are produced. Out of these gamma rays are of main significance. A protection must be provided against them. Thick layers of lead or concrete are provided round the reactor for stopping the gamma rays. Thick layers of metals or plastics are sufficient to stop the alpha and beta particles.

## **7. Coolant**

Coolant flows through and around the reactor core. It is used to transfer the large amount of heat produced in the reactor due to fission of the nuclear fuel during chain reaction. The coolant either transfers its heat to another medium or if the coolant used is water it takes up the heat and gets converted into steam in the reactor which is directly sent to the turbine.

### **Advantages**

- Need less space.
- Fuel consumption is small, hence transportation and storage charges are low.
- Well suited for large power demands.
- Less work men required.

### **Disadvantages**

- Capital cost very high.
- Radioactive wastes, if not disposed properly have adverse effect on environment.
- Maintenance cost high.

## **GAS TURBINE POWER PLANTS**

A gas turbine, also called a combustion turbine, is a type of internal combustion engine. It has an upstream rotating compressor coupled to a downstream turbine, and a combustion chamber in-between.

Energy is added to the gas stream in the combustor, where fuel is mixed with air and ignited. In the high pressure environment of the combustor, combustion of the fuel increases the temperature. The products of the combustion are forced into the turbine section. There, the high velocity and volume of the gas flow is directed through a nozzle over the turbine's blades, spinning the turbine which powers the compressor and, for some turbines, drives their mechanical output. The energy given up to the turbine comes from the reduction in the temperature and pressure of the exhaust gas.

## UNIT-III

### Diesel power plant

#### INTRODUCTION

- Diesel engine power plants are installed *where supply of coal and water is not available in sufficient quantity or where power is to be generated in small quantity or where standby sets are required for continuity of supply such as in hospitals, telephone exchanges, radio stations and cinemas*. These plants in the range of 2 to 50 MW capacity are used as *central stations* for supply authorities and works and they are universally adopted to supplement hydro-electric or thermal stations where standby generating plants are essential for starting from cold and under emergency conditions.
- In several countries, the demand for diesel power plants is increased for electric power generation because of difficulties experienced in construction of new hydraulic plants and enlargement of old hydro-plants. A long term planning is required for the development of thermo and hydro-plants which cannot keep the pace with many times the increased demand by the people and industries.
- The diesel units used for electric generation are *more reliable and long-lived piece of equipment* compared with other types of plants.

#### ADVANTAGES AND DISADVANTAGES OF DIESEL POWER PLANTS

The *advantages and disadvantages* of diesel power plants are listed below :

##### Advantages :

1. Design and installation are very simple.
2. Can respond to varying loads without any difficulty.
3. The standby losses are less.
4. Occupy less space.
5. Can be started and put on load quickly.
6. Require less quantity of water for cooling purposes.
7. Overall capital cost is lesser than that for steam plants.
8. Require less operating and supervising staff as compared to that for steam plants.
9. The efficiency of such plants at part loads does not fall so much as that of a steam plant.
10. The cost of building and civil engineering works is low.
11. Can burn fairly wide range of fuels.
12. These plants can be located very near to the load centres, many times in the heart of the town.
13. No problem of ash handling.
14. The lubrication system is more economical as compared with that of a steam power plant.
15. The diesel power plants are *more efficient than steam power plants* in the range of 150 MW capacity.

##### Disadvantages :

1. High operating cost.
2. High maintenance and lubrication cost.
3. Diesel units capacity is limited. These cannot be constructed in large size.
4. In a diesel power plant noise is a serious problem.
5. Diesel plants cannot supply overloads continuously whereas steam power plant can work under 25% overload continuously.
6. The diesel power plants are not economical where fuel has to be imported.
7. The life of a diesel power plant is quite small (2 to 5 years or less) as compared to that of a steam power plant (25 to 30 years).

### 3.3. APPLICATIONS OF DIESEL POWER PLANT

The diesel power plants find wide application in the following fields :

1. Peak load plant
2. Mobile plants
3. Standby units
4. Emergency plant
5. Nursery station
6. Starting stations
7. Central stations—where capacity required is small (5 to 10 MW)
8. Industrial concerns where power requirement is small say of the order of 500 kW, diesel power plants become more economical due to their higher overall efficiency.

### 3.4. SITE SELECTION

The following factors should be considered while *selecting the site for a diesel power plant* :

1. **Foundation sub-soil condition.** The conditions of sub-soil should be such that a foundation at a reasonable depth should be capable of providing a strong support to the engine.
2. **Access to the site.** The site should be so selected that it is accessible through rail and road.
3. **Distance from the load centre.** The location of the plant should be near the load centre. This reduces the cost of transmission lines and maintenance cost. The power loss is also minimised.
4. **Availability of water.** Sufficient quantity of water should be available at the site selected.
5. **Fuel transportation.** The site selected should be near to the source of fuel supply so that transportation charges are low.

### 3.5. HEAT ENGINES

*Any type of engine or machine which derives heat energy from the combustion of fuel or any other sources and converts this energy into mechanical work is termed as a heat engine.*

Heat engines may be classified into two main classes as follows :

1. External Combustion Engines.
2. Internal Combustion Engines.

1. **External combustion engines (E.C. engines).** In this case, *combustion of fuel takes place outside the cylinder* as in case of *steam engines* where the heat of combustion is employed to

### 3.8.3. Exhaust System

Refer to Fig. 3.3. The purpose of the exhaust system is to discharge the engine exhaust to the atmosphere outside the building. The exhaust manifold connects the engine cylinder exhaust outlets to the exhaust pipe which is provided with a muffler to reduce pressure in the exhaust line and eliminate most of the noise which may result if gases are discharged directly into the atmosphere.

*The exhaust pipe leading out of the building should be short in length with minimum number of bends and should have one or two flexible tubing sections which take up the effects of expansion, and isolate the system from the engine vibration. Every engine should be provided with its independent exhaust system.*

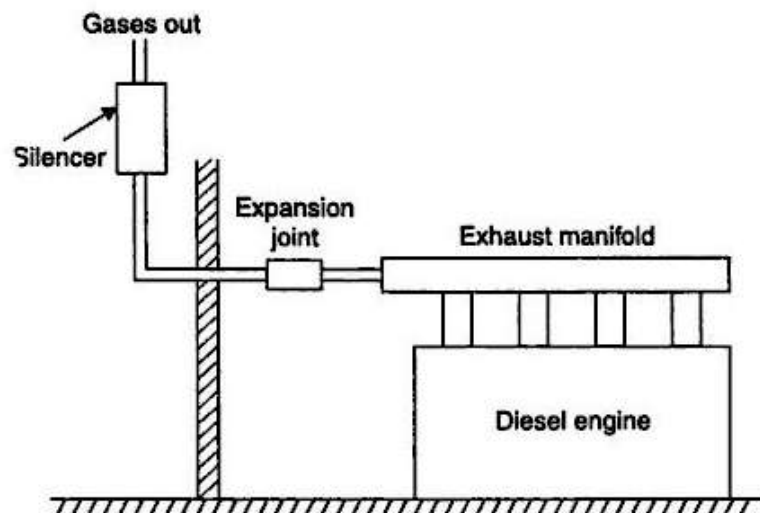

Fig. 3.3. Exhaust system.

The waste heat utilisation in a *diesel-steam* station may be done by providing waste-heat boilers in which most of the heat of exhaust gases from the engine is utilised to raise low pressure steam. Such application is common on *marine plants*. On the *stationary power plant* the heat of exhaust may be utilised to heat water in gas-to-water heat exchangers consisting of a water coil placed in exhaust muffler and using the water in the plant suitably. If air heating is required, the exhaust pipe from the engine is surrounded by the cold air jacket, and transfers the heat of exhaust gases to the air.

### 3.8.4. Fuel System

Refer to Fig. 3.4.

The fuel oil may be delivered at the plant site by trucks, railroad tank cars or barge and tankers. From tank car or truck the delivery is through the unloading facility to main storage tanks and then by transfer pumps to small service storage tanks known as *engine day tanks*. Large storage capacity allows purchasing fuel when prices are low. The main flow is made workable and practical by arranging the piping equipment with the necessary heaters, by passes, shut-offs, drain lines, relief valves, strainers and filters, flow meters and temperature indicators. The actual flow plans depend on type of fuel, engine equipment, size of the plant etc. The tanks should contain manholes for internal access and repair, fill lines to receive oil, vent lines to discharge vapours, overflow return lines for controlling oil flow and a suction line to withdraw oil. *Coils heated by hot water or steam reduce oil viscosity to lower pumping power needs.*

The minimum storage capacity of at least a month's requirement of oil should be kept in bulk, but where advantage of seasonal fluctuations in cost of oil is to be availed, it may be necessary to

provide storage for a few month's requirements. *Day tanks* supply the daily fuel need of engines and may contain a minimum of about 8 hours of oil requirement of the engines. These tanks are usually placed high so that oil may flow to engines under gravity.

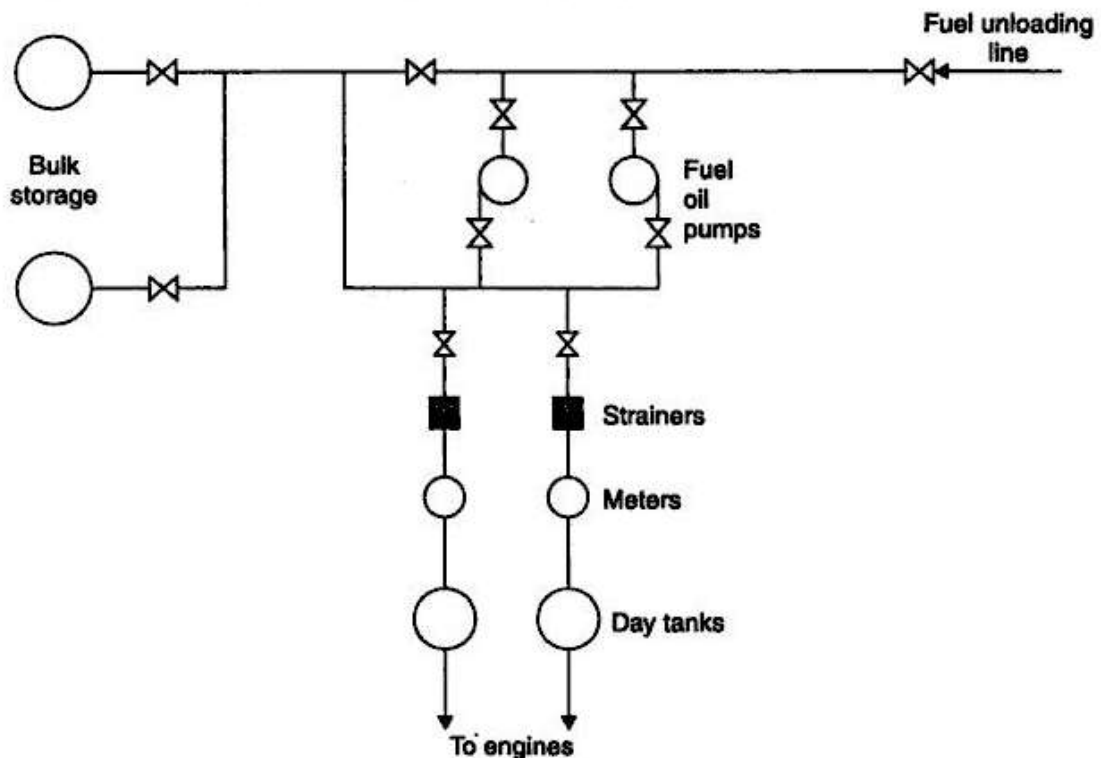

Fig. 3.4. System of fuel storage for a diesel power plant.

For satisfactory operation of a fuel oil supply system the following points should be taken care of :

1. There should be provisions for cleanliness and for changing over of lines during emergencies.
2. In all suction lines the pipe joints should be made tight.
3. Before being covered, all oil lines should be put under air pressure and the joints tested with soap solution. Small air leaks into the line can be the source of exasperating operating difficulties and are hard to remedy once the plant is in operation.
4. The piping between filter and the engine should be thoroughly oil flushed before being first placed in service.
5. Considerable importance should be given for cleanliness in handling bulk fuel oil. Dirt particles will ruin the fine lap of injection pumps or plug the injection nozzle orifices. So *high-grade filters* are of paramount importance to the diesel oil supply system.

#### 3.8.4.1. Fuel injection system

The mechanical heart of the Diesel engine is the *fuel injection system*. The engine can perform no better than its fuel injection system. A very small quantity of fuel must be measured out, injected, atomised, and mixed with combustion air. The mixing problem becomes more difficult—the larger the cylinder and faster the rotative speed. Fortunately the high-speed engines are the small-bore automotive types ; however, special combustion arrangements such as precombustion chambers, air cells, etc., are necessary to secure good mixing. *Engines driving electrical generators have lower speeds and simple combustion chambers.*

### 3.8.4.2. Functions of a fuel injection system

1. Filter the fuel.
2. Meter or measure the correct-quantity of fuel to be injected.
3. Time the fuel injection.
4. Control the rate of fuel injection.
5. Atomise or break up the fuel to fine particles.
6. Properly distribute the fuel in the combustion chamber.

The injection systems are manufactured with great accuracy, especially the parts that actually meter and inject the fuel. Some of the tolerances between the moving parts are very small of the order of *one micron*. Such closely fitting parts require special attention during manufacture and hence the injection systems are *costly*.

### 3.8.4.3. Types of fuel injection systems

The following fuel injection systems are commonly used in diesel power station :

1. Common-rail injection system.
2. Individual pump injection system.
3. Distributor.

Atomisation of fuel oil has been secured by (i) *air blast* and (ii) *pressure spray*. Early diesel engines used air fuel injection at about 70 bar. This is sufficient not only to inject the oil, but also to atomise it for a rapid and thorough combustion. The expense of providing an air compressor and tank lead to the development of "*solid*" injection, using a liquid pressure of between 100 and 200 bar which is sufficiently high to atomise the oil it forces through spray nozzles. Great advances have been made in the field of solid injection of the fuel through research and progress in fuel pump, spray nozzles, and combustion chamber design.

## 3.9. OPERATION OF A DIESEL POWER PLANT

When diesel alternator sets are put in parallel, "*hunting*" or "*phase swinging*" may be produced *due to resonance* unless due care is taken in the design and manufacture of the sets. This condition occurs *due to resonance between the periodic disturbing forces of the engine and natural frequency of the system*. The engine forces result from uneven turning moment on the engine crank which are corrected by the flywheel effect. "*Hunting*" results from the tendency of each set trying to pull the other into synchronism and is characterised by flickering of lights.

To ensure *most economical operation of diesel engines* of different sizes when working together and sharing load it is necessary that they should carry the same percentage of their full load capacity at all times as the fuel consumption would be lowest in this condition. For best operation performance the manufacturer's recommendations should be strictly followed.

In order to get good performance of a diesel power plant the following points should be taken care of :

1. It is necessary to maintain the *cooling temperature* within the prescribed range and use of very cold water should be avoided. The cooling water should be free from suspended impurities and suitably treated to be scale and corrosion free. If the ambient temperature approaches freezing point, the cooling water should be drained out of the engine when it is kept idle.
2. During operation the *lubrication system* should work effectively and requisite pressure and temperature maintained. The engine oil should be of the correct specifications and should be in a fit condition to lubricate the different parts. A watch may be kept on the consumption of lubricating oil as this gives an indication of the true internal condition of the engine.



3. *The engine should be periodically run even when not required to be used and should not be allowed to stand idle for more than 7 days.*

4. *Air filter, oil filters and fuel filters should be periodically serviced or replaced as recommended by the manufacturers or if found in an unsatisfactory condition upon inspection.*

5. *Periodical checking of engine compression and firing pressures and also exhaust temperatures should be made.*

- *The engine exhaust usually provides a good indication of satisfactory performance of the engine. A black smoke in the exhaust is a sign of inadequate combustion or engine overloading.*
- *The loss of compression resulting from wearing out of moving parts lowers the compression ratio causing inadequate combustion. These defects can be checked by taking indicator diagrams of the engine after reasonable intervals.*

### **3.10. TYPES OF DIESEL ENGINES USED FOR DIESEL POWER PLANTS**

The diesel engines may be four-stroke or two stroke cycle engines. *The two-stroke cycle engines are favoured for diesel power plants.*

Efforts are being made to use "dual fuel engines" in diesel power plants for better economy and proper use of available gaseous fuels in the country. The gas may be a waste product as in the case of sewage treatment installations or oil fuels where the economic advantage is self evident. With the wider availability of natural gas, the dual fuel engines may become an attractive means of utilising gas as fuel at off-peak tariffs for the electric power generation.

#### **Working of Dual Fuel Engines :**

The various strokes of a dual fuel engine are as follows :

1. **Suction stroke.** During this stroke *air and gas are drawn* in the engine cylinder.
2. **Compression stroke.** During this stroke the pressure of the mixture drawn is increased. Near the end of this stroke the 'pilot oil' is injected into the engine cylinder. *The compression heat first ignites the pilot oil and then gas mixture.*
3. **Working/power stroke.** During this stroke the gases (at high temperature) expand and thus power is obtained.
4. **Exhaust stroke.** The exhaust gases are released to the atmosphere during the stroke.

### **3.11. LAYOUT OF A DIESEL ENGINE POWER PLANT**

Fig. 3.5 shows the layout of a diesel engine power plant.

The most common arrangement for diesel engines is with parallel centre lines, with some room left for extension in future. The repairs and usual maintenance works connected with such engines necessitate sufficient space around the units and consideration should be given to the need for dismantling and removal of large components of the engine generator set. The air intakes and filters as well as the exhaust mufflers are located outside the building or may be separated from the main engine room by a partition wall. The latter arrangement is not vibration free. Adequate space for oil storage and repair shop as well as for office should be provided close to the main engine room. Bulk storage of oil may be outdoor. The engine room should be well ventilated.

## UNIT-IV

### Hydro-Electric Power Plant

#### INTRODUCTION

- In hydro-electric plants energy of water is utilised to move the turbines which in turn run the electric generators. The energy of water utilised for power generation may be kinetic or potential. The *kinetic energy* of water is its energy in motion and is a function of mass and velocity, while the *potential energy* is a function of the difference in level/head of water between two points. In either case continuous availability of a water is a basic necessity ; to ensure this, water collected in natural lakes and reservoirs at high altitudes may be utilised or water may be artificially stored by constructing dams across flowing streams. The ideal site is one in which a good system of natural lakes with substantial catchment area, exists at a high altitude. *Rainfall is the primary source of water* and depends upon such factors as temperature, humidity, cloudiness, wind etc. The usefulness of rainfall for power purposes further depends upon several complex factors which include its intensity, time distribution, topography of land etc. However it has been observed that only a small part of the rainfall can actually be utilised for power generation. A significant part is accounted for by *direct evaporation*, while another similar quantity *seeps* into the soil and forms the underground storage. Some water is also absorbed by

#### CLASSIFICATION OF HYDRO-ELECTRIC POWER PLANTS

Hydro-electric power stations may be *classified* as follows :

##### A. According to availability of head :

1. High head power plants
2. Medium head power plants
3. Low head power plants.

##### B. According to the nature of load :

1. Base load plants
2. Peak load plants.

##### C. According to the quantity of water available :

1. Run-of-river plant without pondage
2. Run-of-river plant with pondage
3. Storage type plants
4. Pump storage plants
5. Mini and micro-hydel plants



### A. According to availability of head :

The following figures give a rough idea of the heads under which the various types of plants work :

- |                               |                 |
|-------------------------------|-----------------|
| (i) High head power plants    | 100 m and above |
| (ii) Medium head power plants | 30 to 100 m     |
| (iii) Low head power plants   | 25 to 80 m.     |

**Note.** It may be noted that figures given above overlap each other. Therefore it is difficult to classify the plants directly on the basis of head alone. The basis, therefore, technically adopted is the *specific speed* of the turbine used for a particular plant.

#### 5.6.1. High Head Power Plants

These types of plants work under heads ranging from 100 to 2000 metres. Water is usually stored up in lakes on high mountains during the rainy season or during the season when the snow melts. The rate of flow should be such that water can last throughout the year.

Fig. 5.2 shows high head power plant layout. Surplus water discharged by the spillway cannot endanger the stability of the main dam by erosion because they are separated. The tunnel through the mountain has a surge chamber excavated near the exit. Flow is controlled by head gates at the tunnel intake, butterfly valves at the top of the penstocks, and gate valves at the turbines. This type of site might also be suitable for an underground station.

The *Pelton wheel* is the common primemover used in high head power plants.

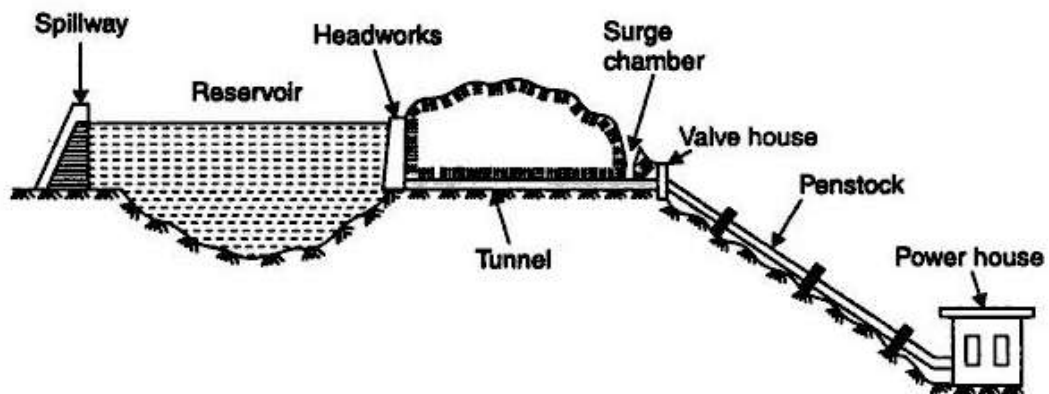

Fig. 5.2. High head power plant layout. The main dam, spillway, and powerhouse stand at widely separated locations. Water flows from the reservoir through a tunnel and penstocks to the turbines.

### 5.6.2. Medium Head Power Plants

Refer Fig. 5.3. When the operating head of water lies between 30 to 100 metres, the power plant is known as medium head power plant. This type of plant commonly uses *Francis turbines*. The forebay provided at the beginning of the penstock serves as water reservoir. In such plants, the water is generally carried in open canals from main reservoir to the forebay and then to the powerhouse through the penstock. The forebay itself works as a surge tank in this plant.

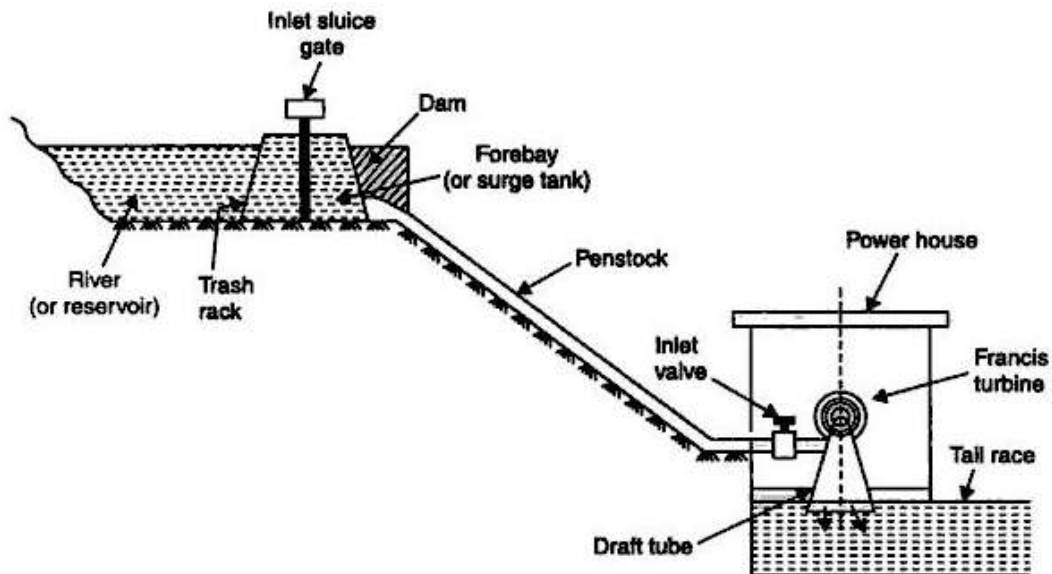

Fig. 5.3. Medium head power plant layout.

### 5.6.3. Low Head Power Plants

Refer Fig. 5.4. These plants usually consist of a dam across a river. A sideways stream diverges from the river at the dam. Over this stream the powerhouse is constructed. Later this channel joins the river further downstream. This type of plant uses vertical shaft Francis turbine or Kaplan turbine.

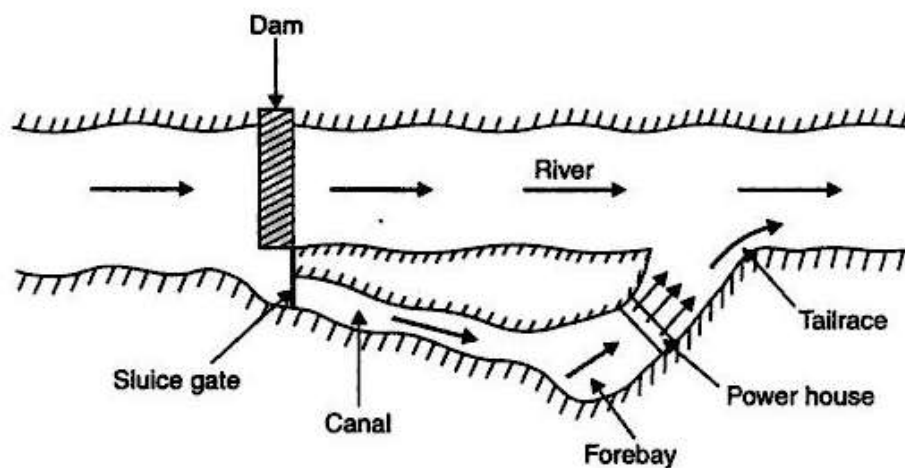

Fig. 5.4. Low head power plant layout.

## **B. According to the nature of load :**

### **5.6.4. Base Load Plants**

*The plants which cater to the base load of the system are called **base load plants**. These plants are required to supply a constant power when connected to the grid. Thus they run without stop and are often remote-controlled with which least staff is required for such plants. Run-of-river plants without pondage may sometimes work as baseload plant, but the firm capacity in such cases, will be much less.*

### **5.6.5. Peak Load Plants**

*The plants which can supply the power during peak loads are known as **peak load plants**. Some of such plants supply the power during average load but also supply peak load as and when it is there ; whereas other peak load plants are required to work during peak load hours only. The run-of-river plants may be made for the peak load by providing pondage.*

## **C. According to the quantity of water available :**

### **5.6.6. Run-of-river Plants without Pondage**

*A run-of-river plant without pondage, as the name indicates, does not store water and uses the water as it comes. There is *no control on flow of water* so that during high floods or low loads water is wasted while during low run-off the plant capacity is considerably reduced. *Due to non-uniformity of supply and lack of assistance from a firm capacity the utility of these plants is much less than those of other types. The head on which these plants work varies considerably.* Such a plant can be made a great deal more useful by providing sufficient storage at the plant to take care of the hourly fluctuations in load. This lends some *firm capacity* to the plant. During good flow conditions these plants may cater to base load of the system, when flow reduces they may supply the peak demands. *Head water elevation for plant fluctuates with the flow conditions.* These plants without storage may sometimes be made to supply the base load, but the firm capacity depends on the minimum flow of river. The run-of-river plant may be made for load service with pondage, though storage is usually seasonal.*

### **5.6.7. Run-of-river Plants with Pondage**

*Pondage usually refers to the collection of water behind a dam at the plant and increases the stream capacity for a short period, say a week. *Storage* means collection of water in up stream reservoirs and this increases the capacity of the stream over an extended period of several months. Storage plants may work satisfactorily as base load and peak load plants.*

*This type of plant, as compared to that without pondage, is *more reliable* and its generating capacity is *less dependent on the flow rates of water available*.*

### **5.6.8. Storage Type Plants**

*A storage type plant is one with a reservoir of sufficiently large size to permit carry-over storage from the wet reason to the dry reason, and thus to supply firm flow substantially more than the minimum natural flow. This plant can be used as base load plant as well as peak load plant as water is available with control as required. The majority of hydro-electric plants are of this type.*

### 5.6.9. Pumped Storage Plants

Refer to Fig. 5.5.

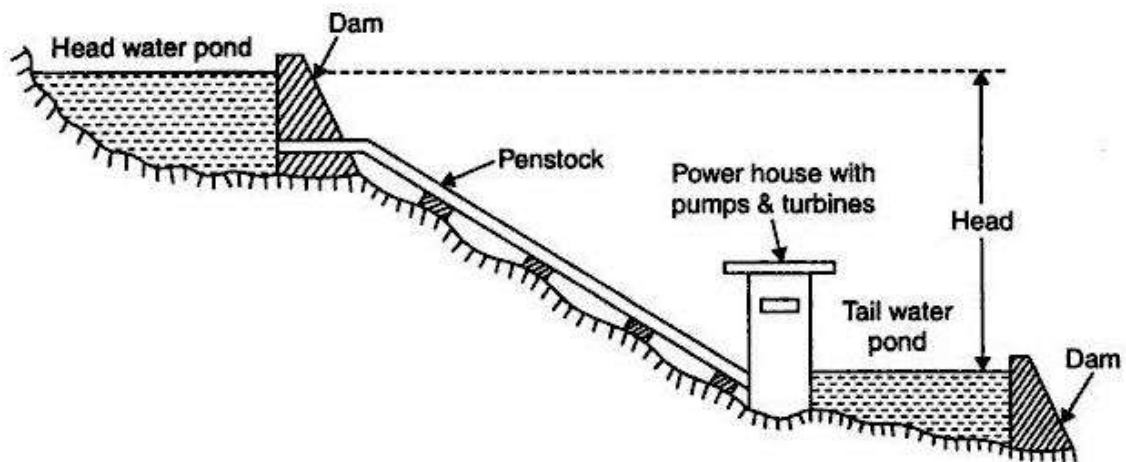

Fig. 5.5. Pumped storage plant.

Pumped storage plants are employed at the places where the quantity of water available for power generation is *inadequate*. Here the water passing through the turbines is stored in 'tail race pond'. During low load periods this water is pumped back to the head reservoir using the extra energy available. This water can be again used for generating power during peak load periods. Pumping of water may be done seasonally or daily depending upon the conditions of the site and the nature of the load on the plant.

Such plants are *usually interconnected* with steam or diesel engine plants so that off peak capacity of interconnecting stations is used in pumping water and the same is used during peak load periods. Of course, the energy available from the quantity of water pumped by the plant is *less* than the energy input during pumped operation. Again while using pumped water the *power available is reduced* on account of losses occurring in primemovers.

**Advantages.** The pump storage plants entail the following *advantages* :

1. There is substantial increase in peak load capacity of the plant at comparatively low capital cost.
2. Due to load comparable to rated load on the plant, the operating efficiency of the plant is high.
3. There is an improvement in the load factor of the plant.
4. The energy available during peak load periods is higher than that of during off peak periods so that inspite of losses incurred in pumping there is *over-all gain*.
5. Load on the hydro-electric plant remains uniform.
6. The hydro-electric plant becomes partly independent of the stream flow conditions.

Under pump storage projects almost 70 percent power used in pumping the water can be recovered. In this field the use of "*Reversible Turbine Pump*" units is also worth noting. These units can be used as turbine while generating power and as pump while pumping water to storage. The generator in this case works as motor during reverse operation. The efficiency in such case is high and almost the same in both the operations. With the use of reversible turbine pump sets, additional capital investment on pump and its motor can be saved and the scheme can be worked more economically.

## **5.7. HYDRAULIC TURBINES**

A hydraulic turbine converts the potential energy of water into mechanical energy which in turn is utilised to run an electric generator to get electric energy.

### **5.7.1. Classification of Hydraulic Turbines**

The hydraulic turbines are *classified* as follows :

- (i) According to the head and quantity of water available.
- (ii) According to the name of the originator.
- (iii) According to the action of water on the moving blades.
- (iv) According to the direction of flow of water in the runner.
- (v) According to the disposition of the turbine shaft.
- (vi) According to the specific speed  $N_s$ .

#### **1. According to the head and quantity of water available :**

- (i) *Impulse turbine*—requires *high head* and *small quantity of flow*.
- (ii) *Reaction turbine*—requires *low head* and *high rate of flow*.

Actually there are two types of reaction turbines, one for medium head and medium flow and the other for low head and large flow.

#### **2. According to the name of the originator :**

(i) *Pelton turbine*—named after Lester Allen Pelton of California (USA). It is an impulse type of turbine and is used for *high head* and *low discharge*.

## **GENERAL ASPECTS OF NUCLEAR ENGINEERING**

### **6.1.1. Atomic Structure**

- An element is defined as a substance *which cannot be decomposed into other substances*. The *smallest particle* of an element which takes part in chemical reaction is known as an '*atom*'. The word atom is derived from Greek word '*Atom*' which means indivisible and for a long time the atom was considered as such. *Dalton's atomic theory* states that (i) all the atoms of one element are precisely alike, have the same mass but differs from the atoms of other elements (ii) the chemical combination consists of the union of a small fixed number of atoms of one element with a small fixed number of other elements.
- Various atomic models proposed by scientists over the last few decades are : 1. Thompson's plum pudding model, 2. Rutherford's nuclear model, 3. Bohr's model, 4. Sommerfeld's model, 5. Vector model, 6. Wave-mechanical model.
- The complex structure of atom can be classified into *electrons* and *nucleus*. The nucleus consists of *protons* and *neutrons* both being referred as *nucleons*. *Protons* are *positively* charged and *neutrons* are *neutral*, thus making complete nucleus as positively charged.
- The *electrons* carry *negative* charge and circulate about the nucleus. As the positive charge on proton particle is equal to the negative charge on electron particle, and the *number of electrons is equal to the number of protons*, atom is a neutral element. Any addition of the number of electrons to the neutral atom will make it negatively charged. Similarly any subtraction of the electrons will make it positively charged. Such an atom is known as *ion* and the process of charging the atom is termed an *ionisation*.
- The nuclear power engineering is specially connected with *variation of nucleons in nucleus*. Protons and neutrons are the particles having the mass of about 1837 times and 1839 times the mass of an electron.



- The modern atomic theory tells that the atom has a diameter of about  $10^{-7}$  mm. In a neutral atom the electrons are bound to the nucleus by the electrostatic forces, which follows the Coloumb's law of forces, i.e., like charges repel and unlike charges attract each other. The function of electrostatic force is similar to the gravitational force.
- The atomic spectrum study has revealed that every electron in an atom is in one group of specific states of motion which is corresponding to its total energy. In an atom the electrons are spinning around the nucleus in orbits. These orbits are called *shells*, which represent the energy levels for the electrons. *All the electrons having very nearly the same total energy are said to be in the same shell.* The shells have been named as *K, L, M, N* etc. Each shell consists of the specific maximum number of electrons. The *K* shell (inner shell) contains 2 electrons, *L* shell has 8 electrons, *M* shell is limited to 18 and the *N* shell possesses 32 electrons. In fact, the number of electrons in any orbit is equal to  $2n^2$  where  $n$  is the serial number of the orbit taking first orbit nearest to the nucleus, *with the exception that the outermost orbit cannot have more than eight electrons.* In a given atom all orbits may not be complete. It is obvious from the study that *amplitude difference in energy between two shells is much more than the difference in between energy levels in one shell.* In a shell less than the specified number of electrons may exist but not a large number. The inner shell is filled up first and then the other successive shells are completed.
- The *chemical properties of the atom varies with composition of number of electrons in various shells and the state of energies within the shells determine the electrical characteristics of the atom.* For example, *Hydrogen (H<sub>2</sub>)* consists of one electron in the first shell, *Helium (He)* has two electrons in the first shell, *Lithium (Li)* has two electrons in first shell and one in second shell, *Carbon (C)* consists of two electrons in first and four in second shell.

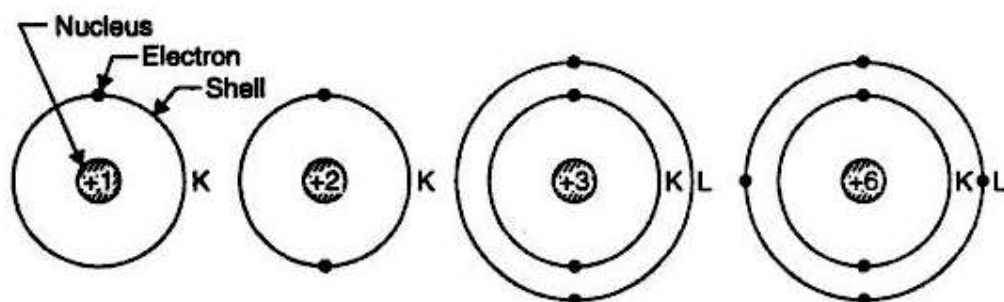

Fig. 6.1 (a). Atomic structure of H<sub>2</sub>, He, Li and C.

- The electrons lying in the outermost shell are termed *valence electrons*. If the outermost shell is completely filled, the atom is stable and will not take any electron to fill up the gap. However, the incomplete outer shell will try to *snatch* the required number of electrons from the adjacent atom in a matter. The binding force between the electron and nucleus is the electrostatic force of attraction. *To emit one electron energy required is more than the electrostatic force of attraction. When the energy is supplied, the electron jumps from one discrete energy level to another permissible level. The process starts from outer shell.* The electron possesses the energy in two forms, i.e., kinetic energy due to its motion and potential energy due to its position with respect to the nucleus. It is obvious that *electrons cannot exist in between the permissible orbits.*
- The charge of nucleus is represented by the *number of protons* present. This number is known as *atomic number* and designated by the letter *Z*. It also shows the position of atom in the periodic table. Hydrogen has only one number but natural uranium has ninety two. The atoms having *higher atomic number* have been developed artificially ranging from

93 to 102. These are einsteinium ( $Z = 99$ ), Fermium ( $Z = 100$ ), and mendelevium ( $Z = 101$ ). Plutonium ( $Z = 94$ ) is an important element to the nuclear power field.

The *mass number* ( $A$ ) is the sum of total number of protons and neutrons in a nucleus. The number of electrons is represented by the letter  $N$ , i.e.,  $N = (A - Z)$ .

### 6.1.2. Atomic Mass Unit

The *mass of the atom is expressed in terms of the mass of the electron*. The unit of mass has been considered as  $\frac{1}{16}$  th of the mass of neutral oxygen atom which contains 8 protons and 8 neutrons. The atomic mass unit (a.m.u.) is equal to  $\frac{1}{16}$  th the mass of oxygen neutral atom.

$$\text{One a.m.u.} = 1.66 \times 10^{-24} \text{ g}$$

$$\text{Mass of proton} = 1837 \text{ me} = \frac{1837 \times 9.1 \times 10^{-28}}{1.66 \times 10^{-24}} = 1.00758 \text{ a.m.u.}$$

$$\text{Mass of neutron} = 1839 \text{ me} = \frac{1839 \times 9.1 \times 10^{-28}}{1.66 \times 10^{-24}} = 1.00893 \text{ a.m.u.}$$

It has been concluded that the density of matter in a nucleus is enormous. It has been investigated that the *radius of nucleus is equal to*  $1.57 \times 10^{-3} \times 3\sqrt{A}$ , where  $A$  is the number of nucleons in nucleus.

The density of uranium by calculations comes to  $1.65 \times 10^{14} \text{ g/cm}^3$ . It has been found by calculations that *natural substance has density millions of times lower than that of nuclear matter*.

**Electron volt.** The energy is expressed in electron volt unit. An electron volt is equal to *work done in moving an electron by a potential difference of one volt*. Or it is the amount of energy acquired by any particle with one electronic charge, when it falls through a potential of one volt.

$$\text{One electron volt} = 1.602 \times 10^{-19} \text{ joule.}$$

### 6.1.3. Isotopes

In any atom, the *number of electrons is equal to number of protons*. This is independent of neutrons in the nucleus. *Atoms having different number of neutrons than the number of protons are known as 'Isotopes.'*

**Example.** Isotopes of hydrogen are shown below [Fig. 6.1 (b)].

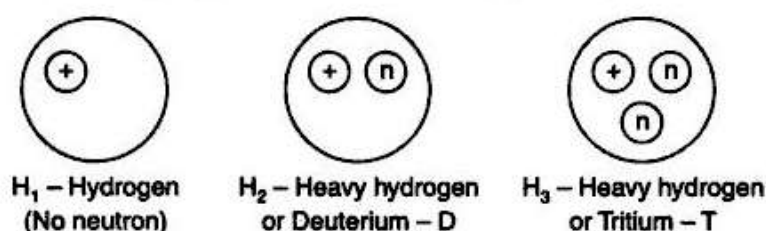

Fig. 6.1 (b).

These isotopes have the *same chemical properties and have the same atomic number and occupy the same place in the periodic table*. But the *nuclear properties* of each of the isotopes are different *because of the different number of neutrons in the nucleus*.

The isotopes of oxygen vary from  $O_{14}$  to  $O_{19}$ . The change of number of neutrons in nucleus affect the mass of atom.

**Example.** Weight of heavy hydrogen is twice the weight of simple hydrogen. This means a volume of  $H_2O$  weighs less than the same volume of  $D_2O$ .



### 6.1.8. Nuclear Reactions

During a nuclear reaction, the *change in the mass of the particle represents the release or an absorption of energy*. If the total mass of the particle after the reaction is reduced, the process releases the energy, consequently, the increase in the mass of the resultant particle, will cause the absorption of energy.

The equations of nuclear reactions are connected with the resettlement of protons and neutrons within the atom. The equations are much similar to chemical reactions. The energy variation is also of the order of MeV. In simple term the equation shows the *balance of neutron and proton*.

A nuclear reaction is written as follows :

- (i) The bombarded nuclei or the target nuclei is written first from left hand side.
- (ii) In the middle within brackets, first is the incident particle and second one the ejected.
- (iii) On the right hand side, the resultant nucleus is placed.

A *neutron* is written as :  ${}_0n^1$  because it has unit mass and it does not have any charge.

An *electron* is written as :  ${}_{-1}e^0$  because its mass is negligible as compared to proton or neutron and its charge is equal but opposite to the charge of proton.

Some of the *examples of reactions* are given below :

- (i) When  ${}_{11}\text{Na}^{23}$  is bombarded with protons possessing high energy, it is converted to  ${}_{12}\text{Mg}^{23}$



(where  $q$  = release or absorption of energy in the reaction)

- (ii) When  ${}_{13}\text{Al}^{27}$  is bombarded with high energy protons it is transformed to  ${}_{14}\text{Si}^{27}$ .



- (iii) When  ${}_{13}\text{Al}^{27}$  is bombarded with deuterons,  $\text{Al}^{28}$  and proton may be produced.



The eqns. (6.10), (6.11) and (6.12) may be written in the equation form as given below :



It is evident from the above mentioned reactions that the *nuclear reaction is followed by capturing a particle, resulting in a compound excited nucleus, which undergoes further transformation in a short period of time.*

The transformation may adopt the following five main different paths :

**1. Elastic scattering.** The neutron interacts with the nucleus and after transformation the compound nucleus emits a particle which is identical to the captured one. There is also no change in the resultant nucleus. The *total internal energy* of the bombarded nucleus and the striking particle *will not change* at all. The process is known as *elastic scattering*. Elastic scattering is also termed as *elastic collision*. When the neutron strikes the nucleus, it imparts the part of initial kinetic energy and momentum to the nucleus which causes the displacement of the nucleus in the crystal lattice by a significant distance and can *change the structural properties of the material*.

In elastic scattering process the *kinetic energy of neutron is reduced and is beneficial to slow down the neutron in reactor*. In this transformation, *there is neither release nor absorption of energy but as a result of collision, redistribution of kinetic energy takes place.*

**Example of elastic scattering.** When a neutron strikes a light nucleus (e.g., hydrogen nucleus), the velocity of the neutron is very much reduced and the energy is transferred to the proton. Here most of the energy is transferred because both the particles are having nearly the *same masses*. It has been observed that in such a single collision, the loss of energy of the proton is nearly 70 to 75 percent. In case the neutron impacts with the heavy nucleus, the energy loss in single collision is *less*. With carbon nucleus this loss amounts to nearly 12 to 17 percent of the initial value. The reaction is written as  $C^{12}(n, n)C^{12}$ .

**2. Inelastic scattering.** The composition of the incident particle and ejected particle remains unchanged. When the particle interacts with the nuclei it loses its kinetic energy and the target nucleus is excited. The energy is released in the form of gamma emission. This transformation is known as *inelastic scattering* or collision. The process is limited to the condition that the neutron should have minimum energy sufficient to excite the target nucleus. The reaction is completed with the absorption or release of energy. The neutron energy loss is of the order of 10 to 20 percent of the initial value.

When a fast moving neutron hits the  $U^{238}$  nucleus, the nucleus is excited and there is an emission of gamma quantum [ $U^{238}(n, \eta\gamma)U^{238}$ ].

**3. Capture.** In this process the incident particle may be captured or absorbed by the nucleus and may raise the mass number by unity. The nucleus is excited and the energy is emitted in the form of gamma quantum. The *artificial radioactive materials are produced by this process*. In a reactor, Co-60 isotope is produced by bombarding the natural Co-59 with neutrons. The reaction has both the possibilities of producing the stable and unstable nucleus and may result in  $(n, \gamma)$  or  $(p, \gamma)$  reactions. This transformation may take place with elastic scattering. When a neutron interacts with light hydrogen, it forms heavy hydrogen, deuterium. The mass of deuterium is less than its components. This mass defect is corresponding to the release of gamma quantum.

**4.** In this reaction, the *impinging particle is trapped in the nucleus but the ejected particle is a different one. The composition of the resultant nucleus is also different from the parent nucleus.*

**5. Fission.** When the nucleus is excited too much, it splits into two mostly equal masses. This particular reaction is suited only to the *heavy nucleus* such as  $U^{233}$ ,  $U^{235}$ ,  $Pu^{239}$  etc. The transformation is known as *fission*. The produced two nuclei are lighter nuclei ; they have *more binding energies per nucleon and hence this reaction always releases the energy* (Fig. 6.2).

### 6.1.9. Nuclear Cross-sections

*Cross-sections (or attenuation coefficients) are measures of the probability that a given reaction will take place between a nucleus or nuclei and incident radiation.*

Cross-sections are called either *microscopic* or *macroscopic*, depending on whether the reference is to a single nucleus or to the nuclei contained in a unit volume of material.

### Microscopic cross-section :

It is a measure of the probability that a given reaction will take place between a single nucleus and an incident particle. Microscopic cross-section is usually denoted by the symbol  $\sigma$  and is expressed in terms of the effective area that a single nucleus presents for the specified reaction. Since these cross sections are usually quite small, in the range of  $10^{-22}$  to  $10^{-26}$  cm<sup>2</sup>/nucleus it is general practice to express them in terms of a unit called the *barn*, which is  $10^{-24}$  cm<sup>2</sup>/nucleus.

### Macroscopic cross-sections :

These are the products of microscopic cross-sections and the atomic density in nuclei per cubic centimeter and are equivalent to the total cross-section, for a specific reaction of all the nuclei in 1 cm<sup>3</sup> of material. Macroscopic cross-sections are denoted by the symbol  $\Sigma$  for *neutrons* and  $\mu$  for *gamma rays* and have the units cm<sup>-1</sup>.

### Gamma ray cross-sections :

Although there are a large number of interaction processes that take place between gamma rays and matter, the most commonly used are the energy-absorption cross-section (used to determine gamma heating and dose rates) and the total attenuation cross-section (used to determine material gamma-ray attenuation and for shielding design).

### Neutron cross-sections :

Neutrons undergo a large number of different interaction processes with matter, and, unlike gamma rays, many of these individual interactions must be evaluated. Neutron cross-sections of general use are :

- |                          |                                   |
|--------------------------|-----------------------------------|
| (i) Fission              | (ii) Gamma-ray production         |
| (iii) Activation         | (iv) Elastic scattering           |
| (v) Inelastic scattering | (vi) Reaction particle production |
| (vii) Total absorption   | (viii) Total attenuation.         |

Both neutron and gamma-ray cross-sections are *energy-dependent properties*. Plots of gamma-ray cross-section vs photon energy for all materials are, over the energy range of interest, *smooth curves*, whereas for neutron cross sections the curves of many materials *show gross variations from a smooth curve*. The variations in neutron cross-sections show up as peaks and valleys on the cross-section plot ; these peaks are called *resonances*. When a material has a large number of resonance peaks over a portion of the energy range, this portion of the cross-section plot is called a *resonance region*. The *resonance region can have a significant effect on reactor design*, since the material U<sup>238</sup> which is present in most fuels has a relatively wide resonance region which can cause extensive neutron absorption during the slowing down of neutrons to thermal energy.

The known cross-sections for materials potentially useful in reactor systems are used as primary criteria in materials selection. For example, high-neutron-absorption cross-section materials would not normally be used as materials of construction in the vicinity of a reactor core to prevent competition for the neutrons required to sustain the fission process ; and high activation cross-section materials would not be chosen, if they can be avoided, in a region exposed to a high neutron flux during operation, if that region is to be accessible after reactor shut-down.

### 6.1.10. Fertile Materials

It has been found that some materials are not fissionable by themselves but they *can be converted to the fissionable materials*, these are known as *fertile materials*.

Pu<sup>239</sup> and U<sup>233</sup> are not found in nature but U<sup>238</sup> and Th<sup>232</sup> can produce them by nuclear reactions. When U<sup>238</sup> is bombarded with slow neutrons it produces  ${}_{92}\text{U}^{239}$  with half-life of 23.5 days which is unstable and undergoes two beta disintegration. The resultant Pu<sup>239</sup> has half-life of  $2.44 \times 10^4$  yrs and is a good alpha emitter.

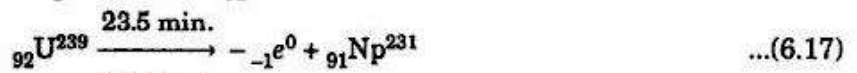

During conversion the above noted reactions will take place. The other isotopes of neptunium such as 2.1 day  $\text{Np}^{238}$  and plutonium can also be produced by the bombardment of heavy particles accelerated by the cyclotron.

The nuclear transformations to convert  ${}_{90}\text{Th}^{232}$  to  $\text{U}^{233}$  are given below :

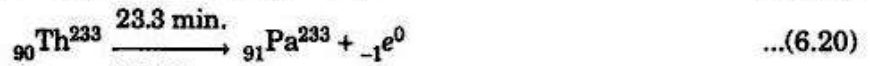

$\text{U}^{235}$  is the source of neutrons required to derive  $\text{Pu}^{239}$  and  $\text{U}^{233}$  from  $\text{Th}^{232}$  and  $\text{U}^{238}$  respectively. This process of conversion is performed in the *breeder reactors*.

**Other fissionable materials.**  $\text{Th}^{227}$ ,  $\text{Pa}^{232}$ ,  $\text{U}^{231}$ ,  $\text{Np}^{238}$  and  $\text{Pu}^{241}$  are the other nuclides which are having high cross-sections for neutron thermal fission.  $\text{Pu}^{241}$  is the important nuclide which is used in plutonium fueled power reactors.

#### 6.1.11. Fission of Nuclear Fuel

**Fission** is the process that occurs when a neutron collides with the nucleus of certain of the heavy atoms, causing the original nucleus to split into two or more unequal fragments which carry off most of the energy of fission as kinetic energy. This process is accompanied by the emission of neutron and gamma rays.

Fig. 6.3 is a representation of the fission of uranium 235. The energy released as a result of fission is the basis for nuclear-power generation. The release of about 2.5 neutrons/fission makes it possible to produce sustained fissioning.

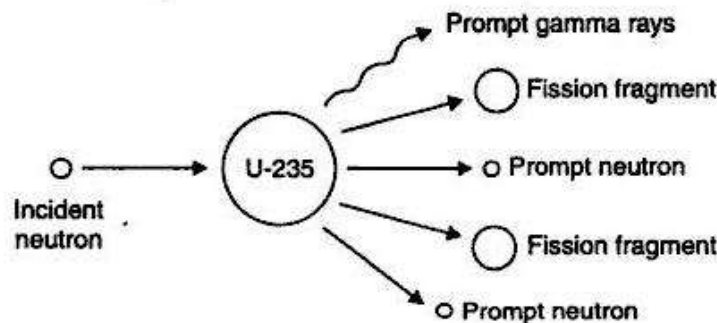

Fig. 6.3. Fission of uranium 235. Incident neutron, upon colliding with  $\text{U}^{235}$  nucleus, causes fission to take place, resulting in the production of fission fragments, prompt neutrons and prompt gamma rays.

The *fission fragments* that result from the fission process are *radioactive* and decay by emission of beta particles, gamma rays and to a lesser extent alpha particles and neutrons. The neutrons that are emitted after fission, by decay of some of the fission fragments, are called *delayed neutrons*. These are of the utmost importance, since they permit the fission chain reaction to be easily controlled.



The total detectable energy released owing to the fission of a single nucleus of uranium 235 is 193 MeV, distributed as shown below :

**Distribution of fission energy**

	MeV
<b>Instantaneous energy release :</b>	
Kinetic energy of fission fragments	168
Prompt-gamma-ray energy	7
Kinetic energy of prompt neutrons	5
Instantaneous total	180
<b>Delayed energy release :</b>	
Beta particle decay of fission products	7
Gamma-ray decay of fission products	6
Delayed total	13

As is shown above, the neutron emitted as a result of fission of a uranium 235 nucleus carry off 5 MeV of kinetic energy. Since on average there are about 2.5 neutrons emitted/U<sup>235</sup> fission, the average neutron energy is 2 MeV. Actually fission neutrons are emitted with an energy spread of from nearly zero energy to approximately 16 MeV, the bulk of the them being in the 1- to 2-MeV energy region.

**Note.** Although not strictly a result of the fission process, there is an additional 5 to 8 MeV emitted per fission as a result of the capture of neutrons not used in the fission chain reaction. About 1 MeV of this total is emitted over a period of time owing to decay of activation products, and the remainder is emitted immediately upon neutron capture.

Most of the reactors in existence today or planned for the near future are called *thermal reactors*, since they depend on neutrons which are in or near thermal equilibrium with their surroundings to cause the bulk of fissions. *These reactors make use of the fact that the probability for fission is highest at low energy by slowing down the neutrons emitted as a result of fissioning to enhance fission captures in the fuel.* Loss of neutrons to non-fission-capture processes is lessened by minimising the quantity of non-fissile material in or near the reactor core. *The materials used to decelerate fast neutrons to thermal energy levels are called moderators.* Effective and efficient moderators must slow the fission neutrons, in the 1- to 2-MeV range to thermal energy at about 0.025 eV to less than 0.1 eV. This effect must be produced in a small volume and with very little absorption.

**The Chain reaction :**

*A chain reaction is that process in which the number of neutrons keeps on multiplying rapidly (in geometrical progression) during fission till whole of the fissionable material is disintegrated.* The chain reaction will become self-sustaining or self propagating only if, for every neutron absorbed, at least one fission neutron becomes available for causing fission of another nucleus. This condition can be conveniently expressed in the form of *multiplication factor or reproduction factor* of the system which may be defined as

$$K = \frac{\text{No. of neutrons in any particular generation}}{\text{No. of neutrons in the preceding generation}}$$

If  $K > 1$ , chain reaction will continue and if  $K < 1$ , chain reaction cannot be maintained.

Fig. 6.4 shows schematically a chain reaction which when set off ultimately leads to a rapidly growing avalanche having the characteristic of an explosion. The rate of growth of the chain process is shown in Fig. 6.5.

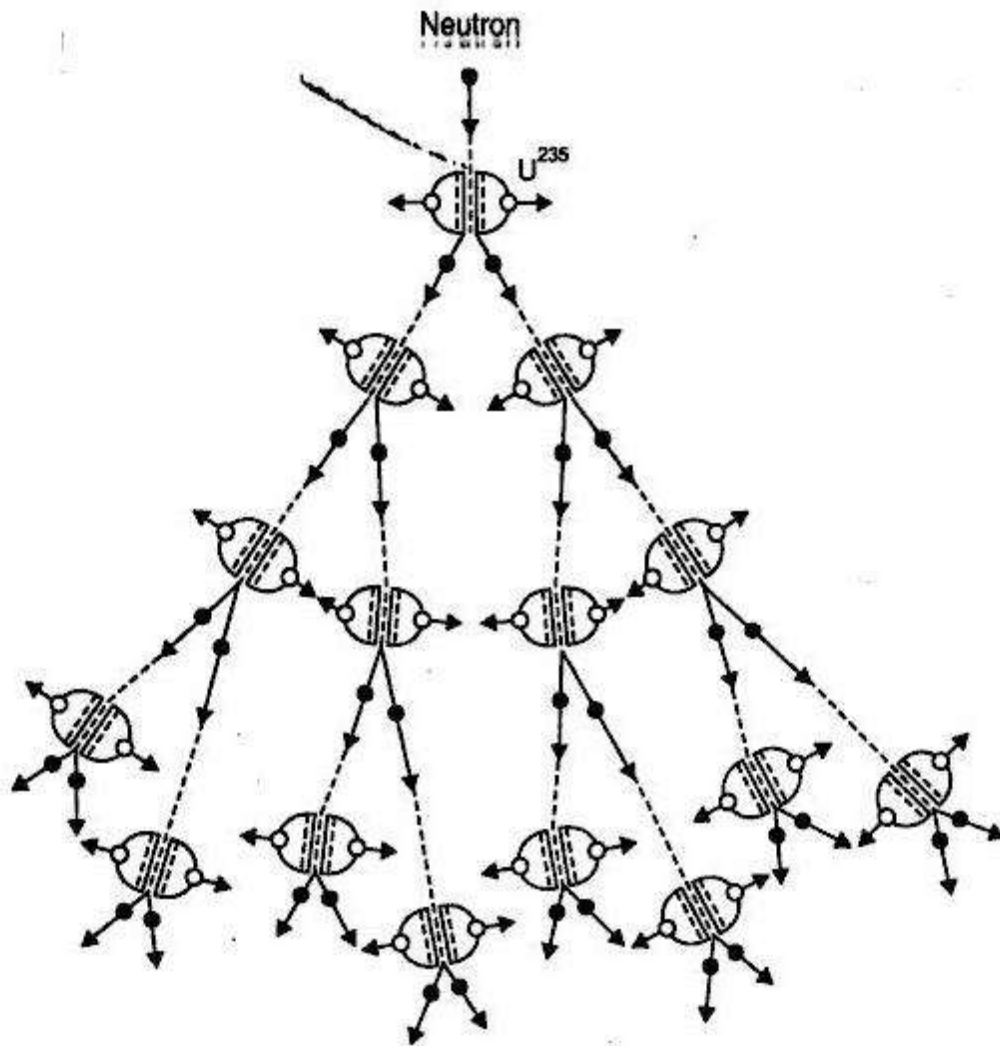

Fig. 6.4. Chain reaction.

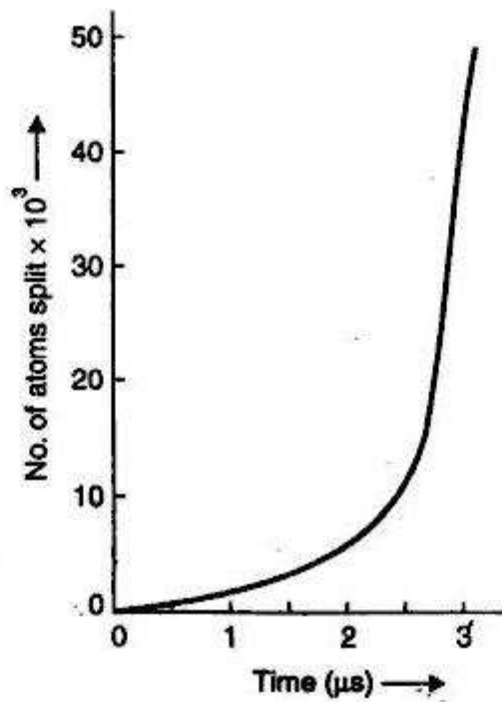

Fig. 6.5. The rate of growth of the chain process.

### 6.3.4. Power of a Nuclear Reactor

The fission rate of a reactor *i.e.*, total number of nuclei undergoing fission per second in a reactor is

$$= nC\sigma NV = \phi_{nu} \sigma NV$$

where,

$n$  = Average neutron density *i.e.*, number per  $m^3$ ,

$C$  = Average speed in m/s,

$\phi_{nu} = nC$  = Average neutron flux,

$N$  = Number of fissile nuclei / $m^3$ ,

$\sigma$  = Fission cross-section in  $m^2$ , and

$V$  = Volume of the nuclear fuel.

Since  $3.1 \times 10^{10}$  fission per second generate a power of one watt, the power  $P$  of a nuclear reactor is given by,

$$P = \frac{nC\sigma NV}{3.1 \times 10^{10}} \text{ watt}$$

$$= 3.2 \times 10^{-11} nC\sigma NV \text{ watt}$$

$$= 3.2 \times 10^{-11} \phi_{nu} \sigma NV \text{ watt}$$

Now,

$NV$  = Total number of fissile nuclei in the reactor fuel

$$= m \times 6.02 \times 10^{26} / 235$$

where,  $m$  is the mass of the  $U^{235}$  fuel. It is known that fission cross-section  $\sigma$  of  $U^{235}$  for thermal neutrons is 582 barns =  $582 \times 10^{-28} m^2$ .

$$P = \frac{3.2 \times 10^{-11} \times \phi_{nu} \times 582 \times 10^{-28} \times m \times 6.02 \times 10^{26}}{235}$$

$$= 4.77 \times 10^{-12} m \phi_{nu} \text{ watt}$$

$$\approx 4.8 \times 10^{-12} m n C \text{ watt.}$$

## 6.4. MAIN COMPONENTS OF A NUCLEAR POWER PLANT

Fig. 6.11 shows schematically a nuclear power plant.

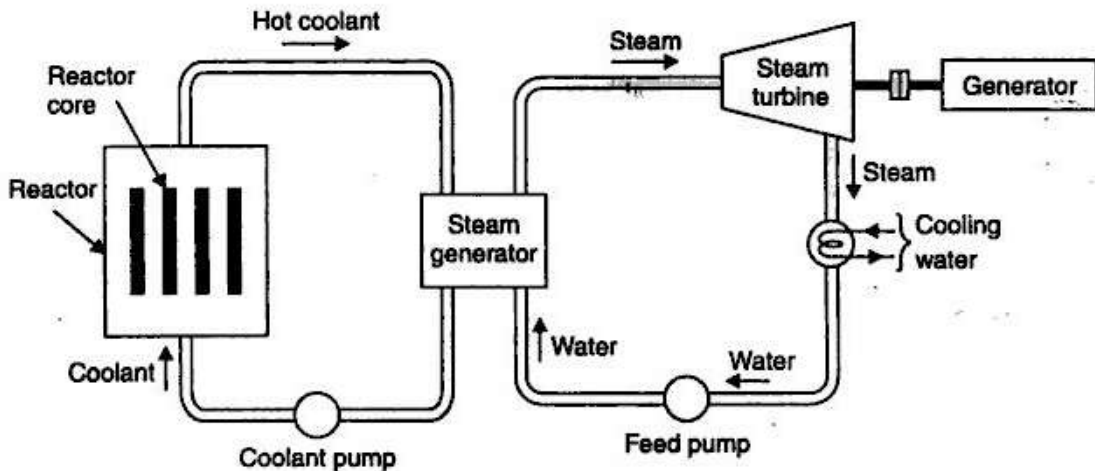

Fig. 6.11. Nuclear power plant.

The main components of a nuclear power plant are :

1. Nuclear reactor
2. Heat exchanger (steam generator)
3. Steam turbine
4. Condenser
5. Electric generator.

In a nuclear power plant the reactor performs the same function as that of the furnace of steam power plant (*i.e.*, produces heat). The heat liberated in the reactor as a result of the nuclear fission of the fuel is taken up by the coolant circulating through the reactor core. Hot coolant leaves the reactor at the top and then flows through the tubes of steam generator and passes on its heat to the feed water. The steam so produced expands in the steam turbine, producing work and thereafter is condensed in the condenser. The steam turbine in turn runs an electric generator thereby producing electrical energy. In order to maintain the flow of coolant, condensate and feed water pumps are provided as shown in Fig. 6.11.

## 6.5. DESCRIPTION OF REACTORS

### 6.5.1. Pressurised Water Reactor (PWR)

A pressurised water reactor, in its simplest form, is a light water-cooled and moderated thermal reactor having an unusual core design, using both natural and highly enriched fuel. The principal parts of the reactor are :

1. Pressure vessel
2. Reactor thermal shield
3. Fuel elements
4. Control rods
5. Reactor containment
6. Reactor pressuriser.

The components of the secondary system of pressurised water plant are similar to those in a normal steam station.

Refer to Fig. 6.12. In PWR, there are two circuits of water, one *primary circuit* which passes through the fuel core and is *radioactive*. This primary circuit then produces steam in a *secondary circuit* which consists of heat exchanger or the boiler and the turbine. As such the steam in the



turbine is *not radioactive* and need not be shielded. The *pressure* in the primary circuit should be *high* so that the boiling of water takes place at high pressure. A *pressuring tank* keeps the water at about  $100 \text{ kgf/cm}^2$  so that it will not boil. Electric heating coils in the pressuriser boil some of the water to form steam that collects in the dome. As more steam is forced into the dome by boiling, its pressure rises and pressurises the entire circuit. The pressure may be reduced by providing cooling coils or spraying water on the steam.

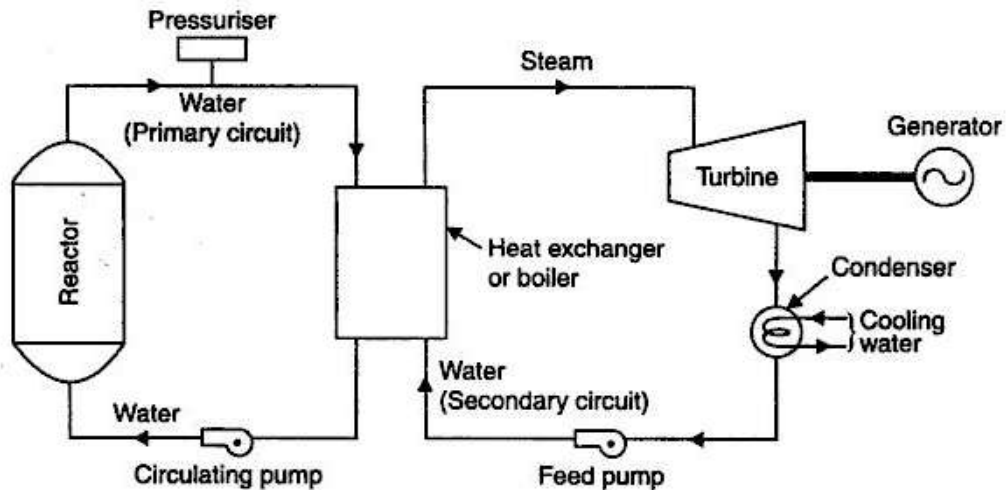

Fig. 6.12. Pressurised water reactor.

*Water acts both as coolant as well as moderator.* Either heavy water or the light water may be used for the above purpose.

A pressurised water reactor can produce only saturated steam. By providing a separate furnace, the steam formed from the reactor could be superheated.

#### Advantages of PWR :

1. Water used in reactor (as coolant, moderator and reflector) is cheap and easily available.
2. The reactor is compact and power density is high.
3. Fission products remain contained in the reactor and are not circulated.
4. A small number of control rods is required.
5. There is a complete freedom to inspect and maintain the turbine, feed heaters and condenser during operation.
6. This reactor allows to reduce the fuel cost extracting more energy per unit weight of fuel as it is ideally suited to the utilisation of fuel designed for higher burn-ups.

#### Disadvantages :

1. Capital cost is high as high primary circuit requires strong pressure vessel.
2. In the secondary circuit the thermodynamic efficiency of this plant is quite low.
3. Fuel suffers radiation damage and, therefore its reprocessing is difficult.
4. Severe corrosion problems.
5. It is imperative to shut down the reactor for fuel charging which requires a couple of month's time.
6. Low volume ratio of moderator to fuel makes fuel element design and insertion of control rods difficult.
7. Fuel element fabrication is expensive.

### 6.5.2. Boiling Water Reactor (BWR)

In a boiling water reactor *enriched fuel* is used. As compared to PWR, the arrangement of BWR plant is simple. The plant can be safely operated using natural convection within the core or forced circulation as shown in the Fig. 6.13. For the safe operation of the reactor the pressure in the forced circulation must be maintained constant irrespective of the load. In case of *part load operation of the turbine some steam is by-passed*.

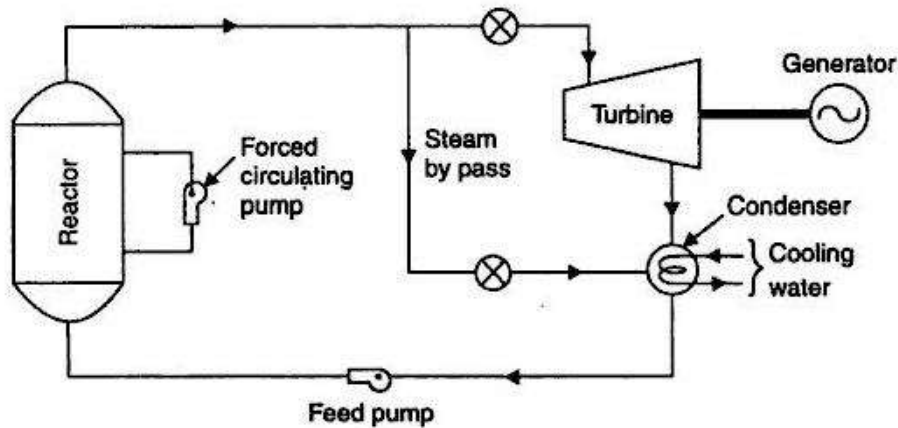

Fig. 6.13. Boiling water reactor.

#### Advantages of BWR :

1. Heat exchanger circuit is eliminated and consequently there is gain in thermal efficiency and gain in cost.
2. There is use of a lower pressure vessel for the reactor which further reduces cost and simplifies containment problems.
3. The metal temperature remains low for given output conditions.
4. The cycle for BWR is more efficient than PWR for given containment pressure, the outlet temperature of steam is appreciably higher in BWR.
5. The pressure inside the pressure vessel is not high so a thicker vessel is not required.

#### Disadvantages :

1. Possibility of radioactive contamination in the turbine mechanism, should there be any failure of fuel elements.
2. More elaborate safety precautions needed which are costly.
3. Wastage of steam resulting in lowering of thermal efficiency on part load operation.
4. Boiling limits power density ; only 3 to 5% by mass can be converted to steam per pass through the boiler.
5. The possibility of "burn out" of fuel is more in this reactor than PWR as boiling of water on the surface of the fuel is allowed.

### 6.5.3. CANDU (Canadian-Deuterium-Uranium) Reactor

CANDU is a thermal nuclear power reactor in which *heavy water* (99.8% deuterium oxide  $D_2O$ ) is the moderator and coolant, as well as the neutron reflector. This reactor was developed in Canada and is being extensively used in this company. A few CANDU reactors are operating or under construction in some other countries as well.

In this type of reactor the *natural uranium* (0.7%  $U^{235}$ ) is used as fuel and heavy water as moderator. These reactors are more economical to those countries which do not produce enriched uranium, as the *enrichment of uranium is very costly*.

CANDU (heavy water) reactor, differs basically from light-water reactors (LWRs) in that in the latter the *same water serves as both moderator and coolant*, whereas in the *CANDU reactor the moderator and coolant are kept separate*. Consequently unlike the pressure vessel of a LWR, the CANDU reactor vessel, which contains the relatively cool heavy water moderator, *does not have to withstand a high pressure*. Only the heavy water coolant circuit has to be pressurised to inhibit boiling in the reactor core.

#### Description of CANDU reactor

Fig. 6.14 shows the schematic arrangement of a CANDU reactor.

**Reactor vessel and core.** The reactor vessel is a steel cylinder with a horizontal axis ; the length and diameter of a typical cylinder being 6 m and 8 m respectively. The vessel is penetrated by some 380 horizontal channels called *pressure tubes* because they are designed to withstand a high internal pressure. The channels contain the fuel elements and the pressurised coolant flows along the channels and around the fuel elements to remove the heat generated by fission. Coolant flows in the opposite directions in adjacent channels.

The high pressure (10 MPa) and high temperature (370°C) coolant leaving the reactor core enters the steam generator. About 5% of fission heat is generated by fast neutrons escaping into the moderator, and this is removed by circulation through a separate heat exchanger.

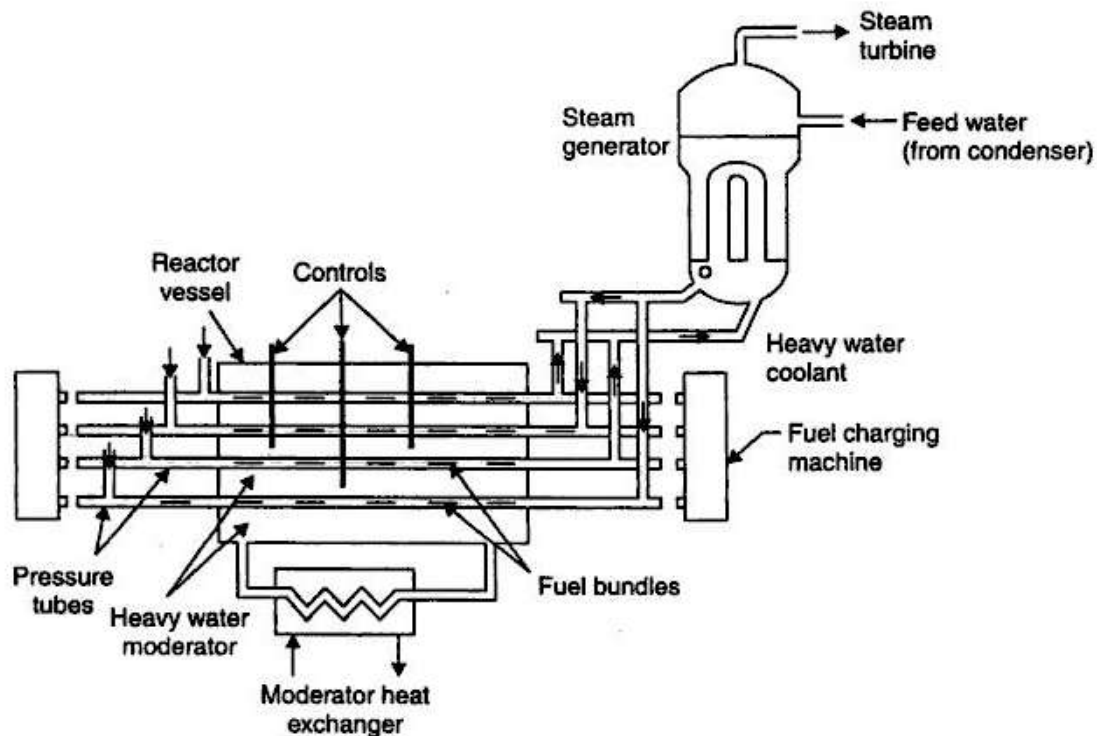

Fig. 6.14. CANDU reactor.

**Fuel.** In a CANDU reactor the fuel is *normal* (i.e., unenriched) *uranium oxide* as small cylinder pellets. The pellets are packed in a corrosion resistance zirconium alloy tube, nearly 0.5 long and 1.3 cm diameter, to form a fuel rod. The relatively short rods are combined in bundles of 37 rods, and

12 bundles are placed end to end in each pressure tube. The total mass of fuel in the core is about 97,000 kg. The CANDU reactor is *unusual in that refueling is conducted while the reactor is operating.*

**Control and protection system :**

There are the various types of vertical control system incorporated in the CANDU reactor :

- A number of strong neutron absorber rods of cadmium which are used mainly for reactor shut-down and start-up.
- In addition to above there are other *less strongly*, absorbing rods to control power variations during reactor operation and to produce an approximately uniform heat (power) distribution throughout the core.

In an emergency situation, the shut-down rods would immediately drop into the core, followed, if necessary by the injection of a gadolinium nitrate solution into the moderator.

**Steam system.** Steam system is discussed below :

- The respective ends of the pressure tubes are all connected into inlet and outlet headers.
- The high temperature coolant leaving the reactor passes out the outlet header to a steam generator of the conventional inverted U-tube and is then pumped back into the reactor by way of the inlet header.
- Steam is generated at a temperature of about 265°C.

There are two coolant outlet (and two inlet) headers, one at each end of the reactor vessel, corresponding to the opposite directions of coolant flow through the core. Each inlet (and outlet) header is connected to a separate steam generator and pump loop. A single pressurizer (of the type used in pressurised water reactors) maintains an essentially constant coolant system pressure.

The reactor vessel and the steam generator system are enclosed by a *concrete containment structure*. A water spray in the containment would condense the steam and reduce the pressure that would result from a large break in the coolant circuit.

**Advantages of CANDU reactor :**

1. Heavy water is used as moderator, which has higher multiplication factor and low fuel consumption.
2. Enriched fuel is not required.
3. The cost of the vessel is less as it has not to withstand a high pressure.
4. Less time is needed (as compared to PWR and BWR) to construct the reactor.
5. The moderator can be kept at low temperature which increases its effectiveness in slowing down neutrons.

**Disadvantages :**

1. It requires a very high standard of design, manufacture and maintenance.
2. The cost of heavy water is very high.
3. There are leakage problems.
4. The size of the reactor is extremely large as power density is low as compared with PWR and BWR.

**6.5.4. Gas-Cooled Reactor**

In such a type of reactor, the coolant used can be air, hydrogen, helium or carbondioxide. Generally inert gases are used such as helium and carbondioxide. The moderator used is *graphite*. The problem of corrosion is reduced much in such reactors. This type of reactor is more safe specially in case of accidents and the failure of circulating pumps. The thickness of gas cooled reactor shield is much reduced as compared to the other types of reactors.